



Hydraulic sampling chair

512 range

512 05T

CARINA
Medical



CE
ISO 9001
ISO 13485

TECHNICAL DETAILS

- 3 sections hydraulic sampling chair, 360° rotating (possibility to block the rotation)
- Backrest and legrest adjustment via independent gas jacks
- Trendelenburg position
- Upholstery without visible seam with good density 35kg/cm², M1 fire retardant class, thickness 8cm
- Equipped with 2 blood test splints, adjustable in every positions with serrated blocks system
- Epoxy covering, light grey colour (RAL 7035) in standard

DIMENSIONS

- Width 55cm
- Adjustable height from 55cm to 74cm
- Load capacity : 130kg in dynamic

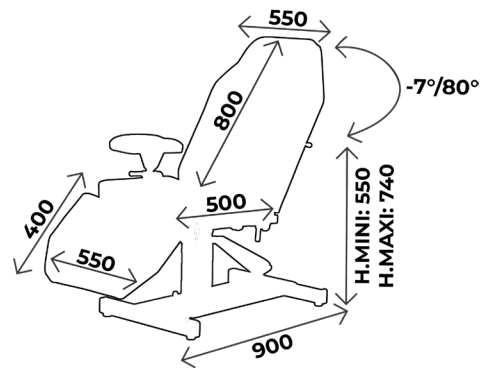

OTHER ELEMENTS

All our chairs can be put in **lying position**



WHAT YOU NEED TO KNOW

- ✓ Delivery time: 15 days upon receipt of order
- ✓ Warranty : 2 years (1 year for the upholstery)

ACCESSORIES



ACC 537
Pair of clamps diam. 14mm for blood test splints and stirrups for all ranges except LUVIA



ACC 535
Pair of double clamps diam. 14 and diam. 16mm to fix both armrest and infusion stand

ACC 516
Option synchronized backrest and legrest



ACC 105
Pair of stainless steel stirrups diam. 14mm without clamp



ACC 964
Pair of legrests on knee system in black polyurethane, diam. 14 mm, without clamp



SLFEMIREPOSE
Cover for legrests ACC964 in upholstery, the unit



ACC 514-GOUT
Plastic protection for blood test splint, the unit



ACC 514-ASSISE
Plastic protection for seatrest



ACC 514-JAMBIÈRE
Plastic protection for legrest



ACC 517-512
Plastic protection for backrest

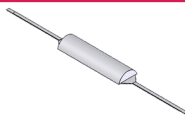

ACC 54005
Half moon head rest width 60cm fire retardant M1 class



ACC 910-PLAT02
Stainless steel tray 340x340 with clamp

ACC 910-PLAT04
Plastic tray 350x270 with clamp



ACC 113U
Pair of handles without clamp with U shape



ACC 113U-105
Pair of handles with clamps to fix both handles and stirrups



ACC 125
Paper roll holder for all models



ACC 32012
Stainless steel infusion stand diam. 16mm, 2 plastic hooks, without clamp



ACC 32014
Stainless steel infusion stand diam. 16mm, 2 stainless steel hooks without clamp

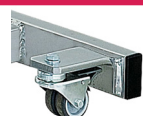

ACC 9505
Set of 4 wheels with brake diam. 50mm



ACC 993-FIXE
4 retractable wheels diam. 50mm



ACC TETERGO
Ergonomic headrest



ACC 110
Blood test splint in colour without clamp, the unit

UPHOLSTERY'S COLOURS

Fire retardant
upholstery, M1 class

For the upholstery colours, you can choose between the Classic and Urban range
Be careful ! Urban colours **with extra value**

Upholstery : Classic range



Arno



Garonne



Potomac

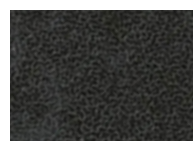

Amour



Mississippi

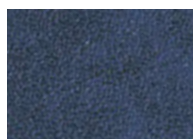

St Laurent

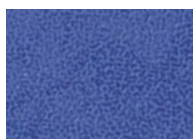

Rhône

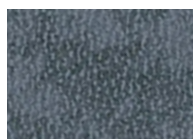

Missouri



Seine

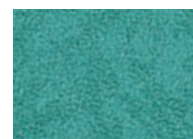

Amazone

Upholstery : Urban range



Abysses

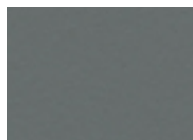

Cendre



Origan



Géranium



Réglisse



Prune

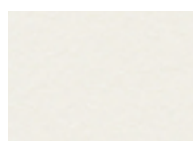

Perle

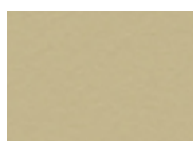

Ficelle

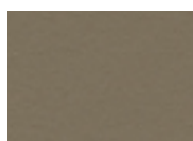

Terre

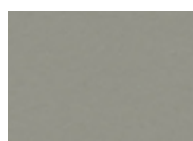

Béton

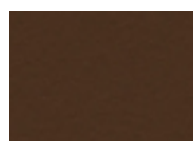

Chataigne

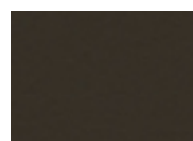

Chocolat



Pensée



Pétrole



Turquoise



Granny



Absinthe



Ananas



Orange



Fuschia





Tomate



BASE COLOURS

The entire 512 range is offered in light grey (RAL 7035) as standard
Possibility to change the color without extra charge

Base colour

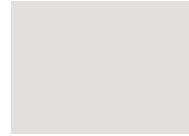
				
RAL 9003	RAL 1013	RAL 1015	RAL 6019	RAL 6033
				
RAL 6000	RAL 5017	RAL 5002	RAL 5000	RAL 7035
				
RAL 7016	RAL 9005	RAL 1018	RAL 3020	RAL 3003
				
		SILVER		



MAINTENANCE GUIDE

DAILY MAINTENANCE

Upholstery : Cleaning with soapy water only (no solvents), can be disinfected with products such as Phagosept Spray, Salvanios pH10 at 0.75% and Anios Surfaces Hautes, without abrasive material

Base : cleaning with soapy water only (no solvents) without abrasive materials

WARRANTY

Mechanical/ electrical part : 2 years

Upholstery : 1 year



CONTACT

CARINA
Médical

Parc d'entreprises Visionis
278 rue de l'industrie
01090 GUÉREINS- FRANCE

COMMERCIAL DEPARTMENT

Tél : +33(0)4 74 66 69 49
Fax : +33(0)4 74 66 69 50
export@carinamedical.com